

□ の なかに ひとつだけ ちがうものが あるよ！
ちがうものに まるを つけよう！

1

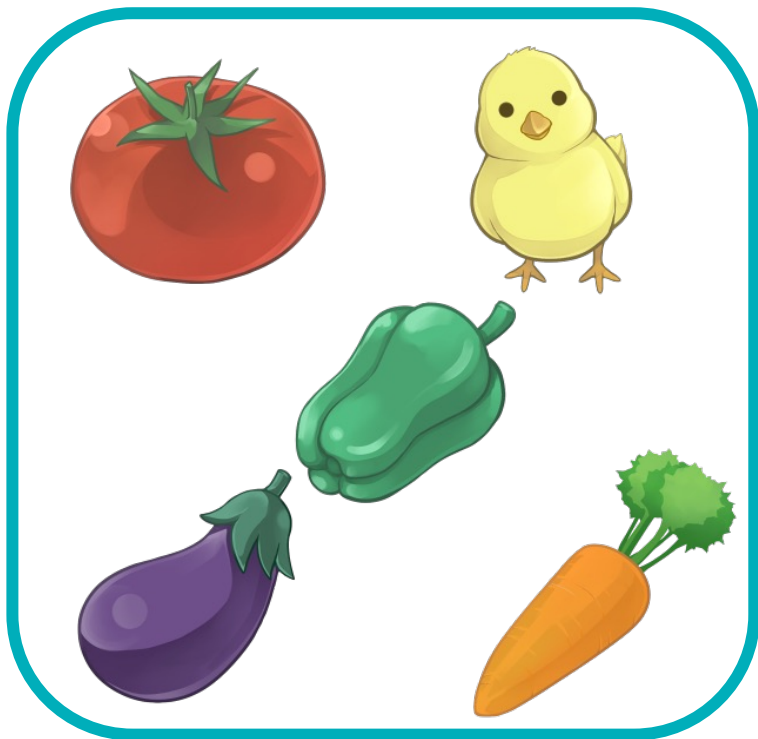

2



□ の なかに ひとつだけ ちがうものが あるよ！
ちがうものに まるを つけよう！

1

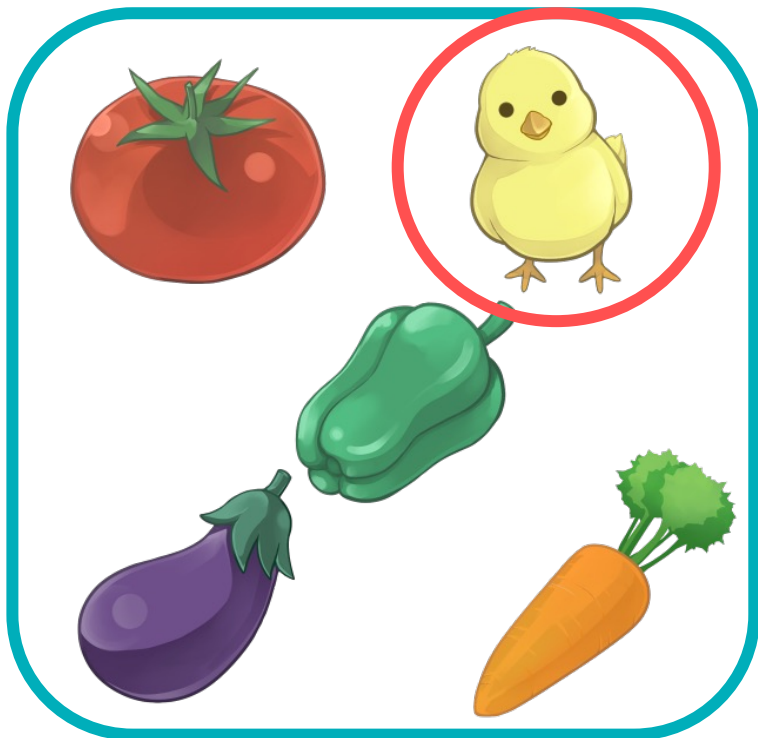

2



□ の なかに ひとつだけ ちがうものが あるよ！
ちがうものに まるを つけよう！

1



2



□ の なかに ひとつだけ ちがうものが あるよ！
ちがうものに まるを つけよう！

1



2

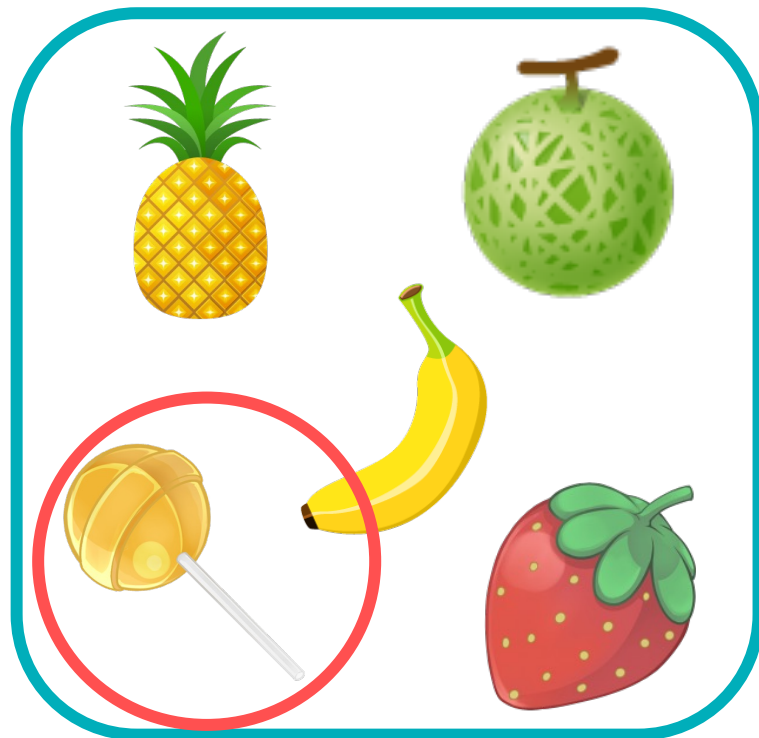

みほんは どちらと おなじ しゅるいかな？

1

みほん

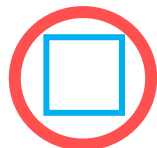

2

みほん



みほんは どちらと おなじ しゅるいかな？

1

みほん

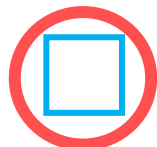

2

みほん

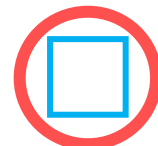

みほんは どちらと おなじ しゅるいかな？

1

みほん



2

みほん

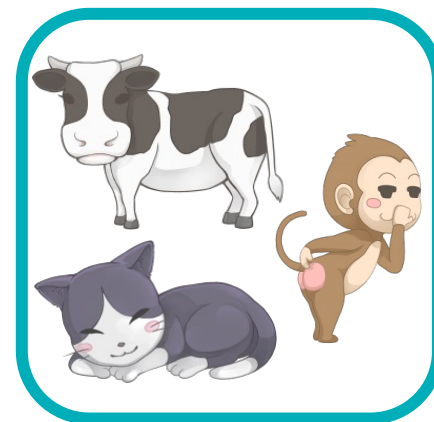

みほんは どちらと おなじ しゅるいかな？

1

みほん

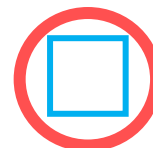

2

みほん

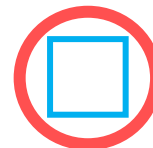

みほんとおなじ かたちは どれかな？

みほん

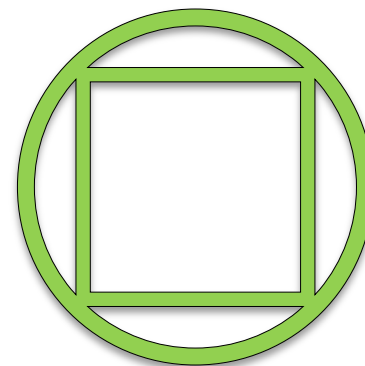
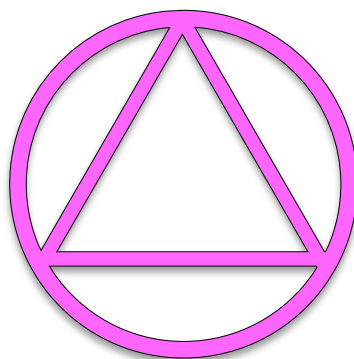
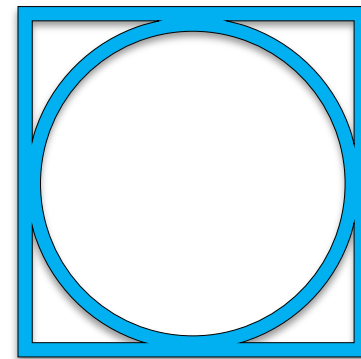
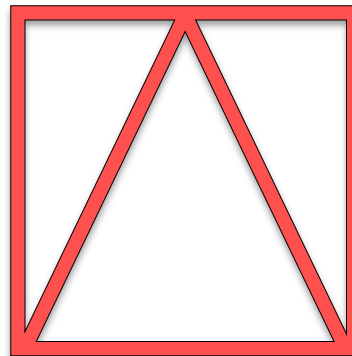
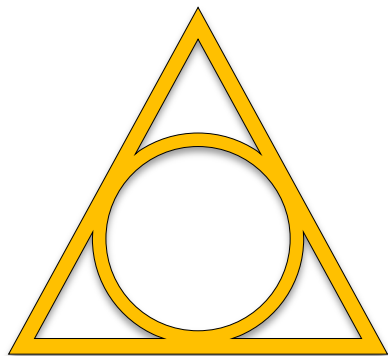
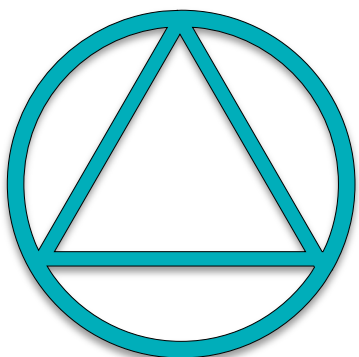

みほんとおなじ かたちは どれかな？

みほん

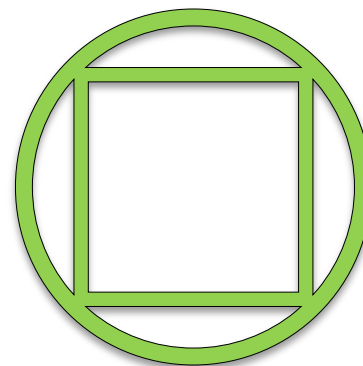
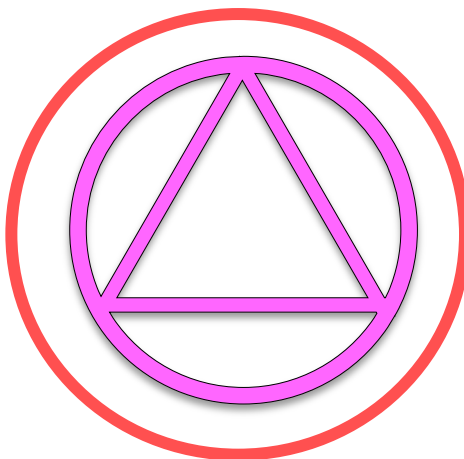
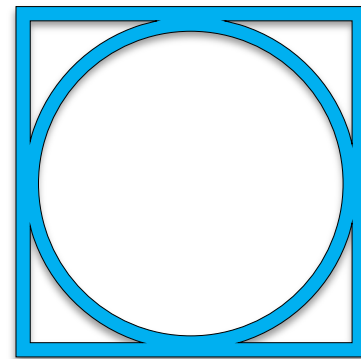
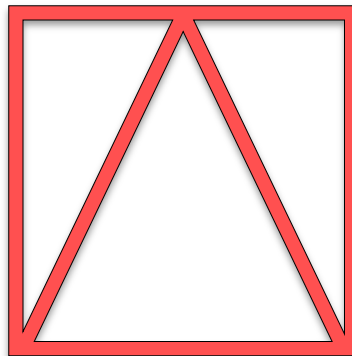
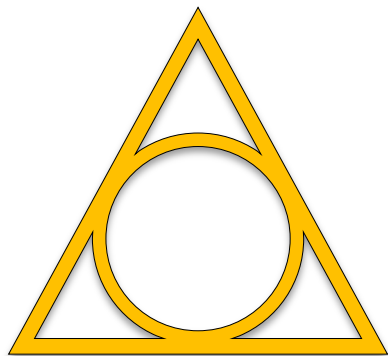
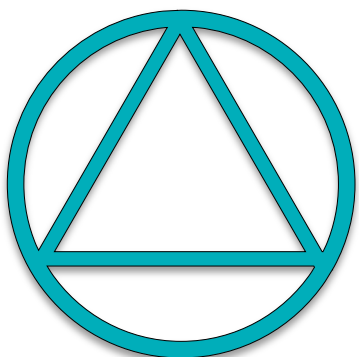

みほんとおなじ かたちは どれかな？

みほん

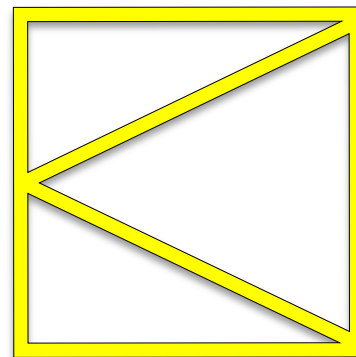
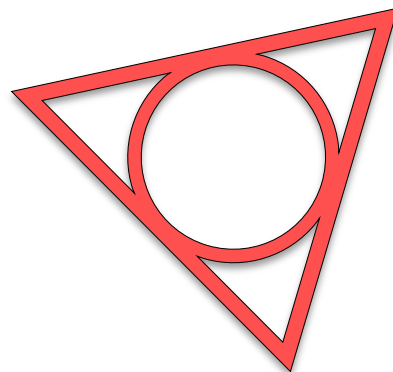
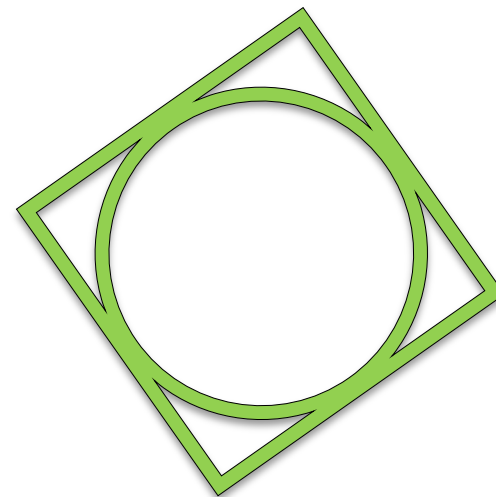
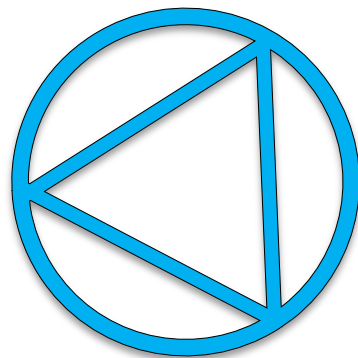
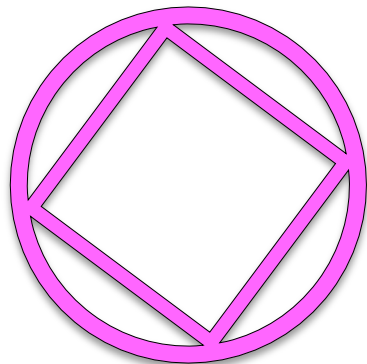
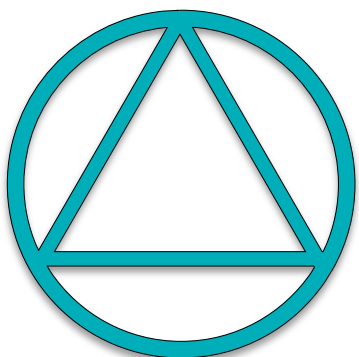

まわしても

おなじ かたちだよ！



みほんとおなじ かたちは どれかな？

みほん

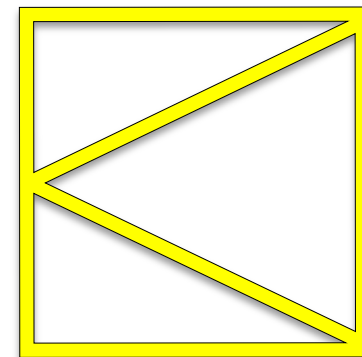
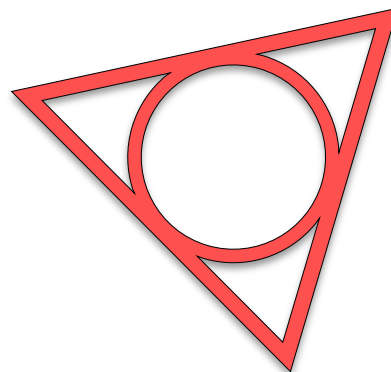
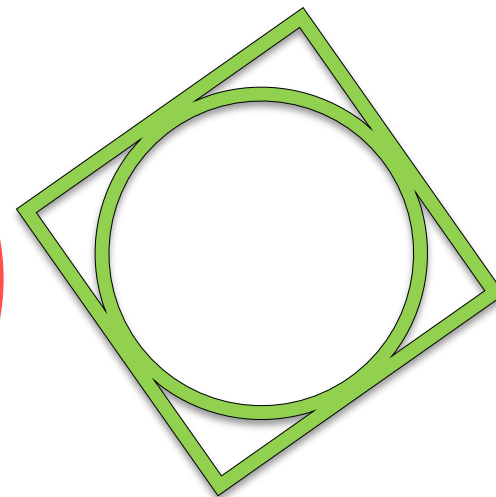
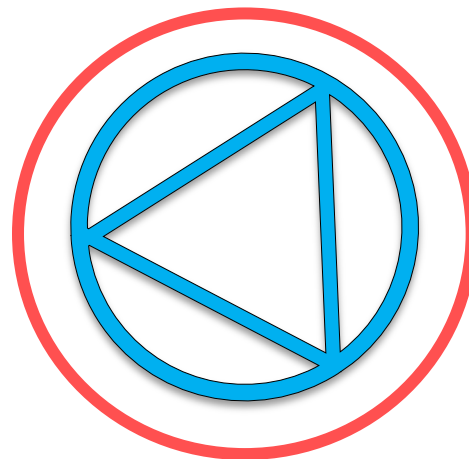
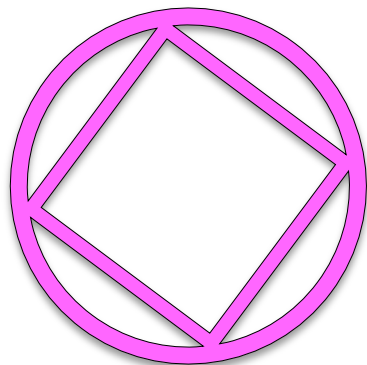
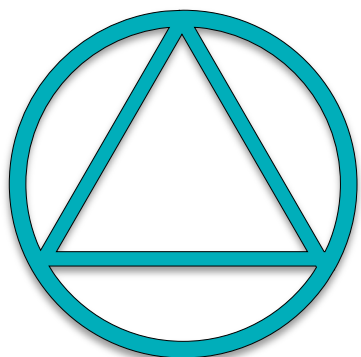

まわしても
おなじ かたちだよ！



シーソーは おもい ほうに かたむくよ。
おもい ほうに まるを つけよう！

1

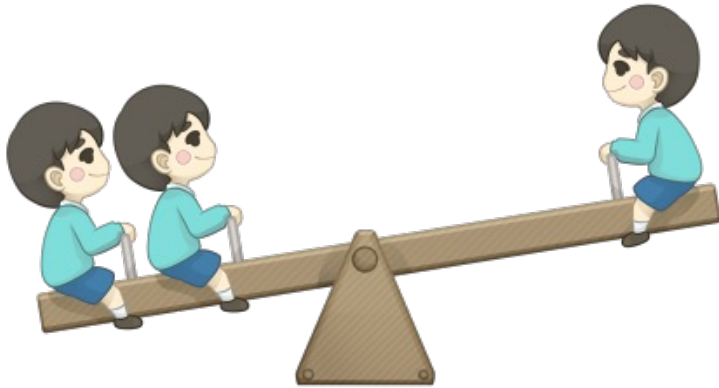

2

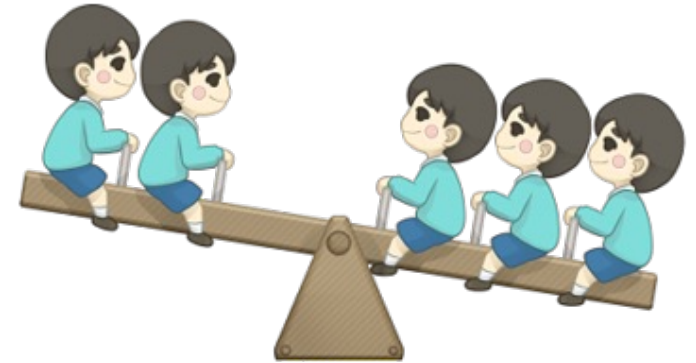

シーソーは おもい ほうに かたむくよ。
おもい ほうに まるを つけよう！

1

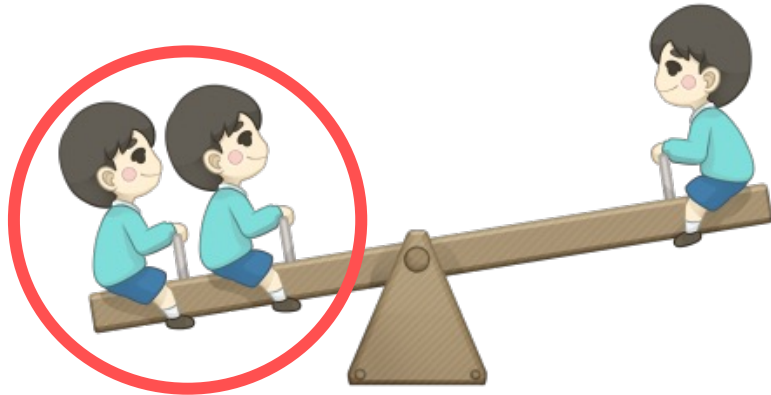

2

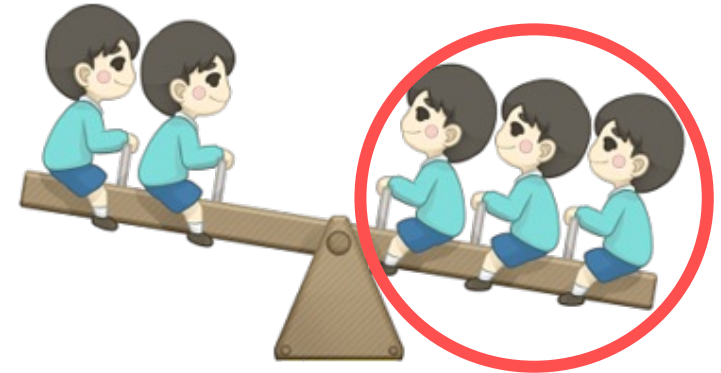

てんびんは おもい ほうに かたむくよ。
おもい ほうに まるを つけよう！

1

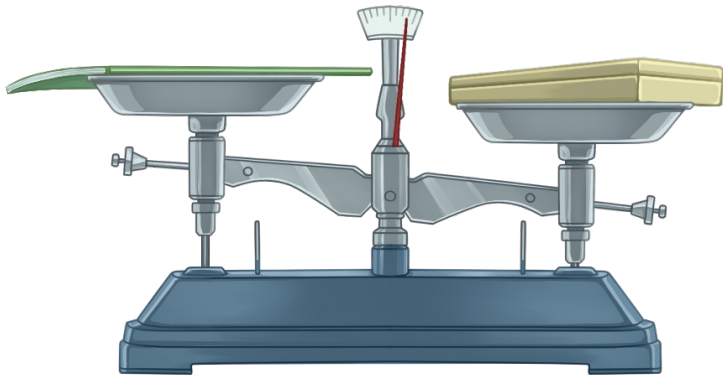

2



てんびんは おもい ほうに かたむくよ。
おもい ほうに まるを つけよう！

1

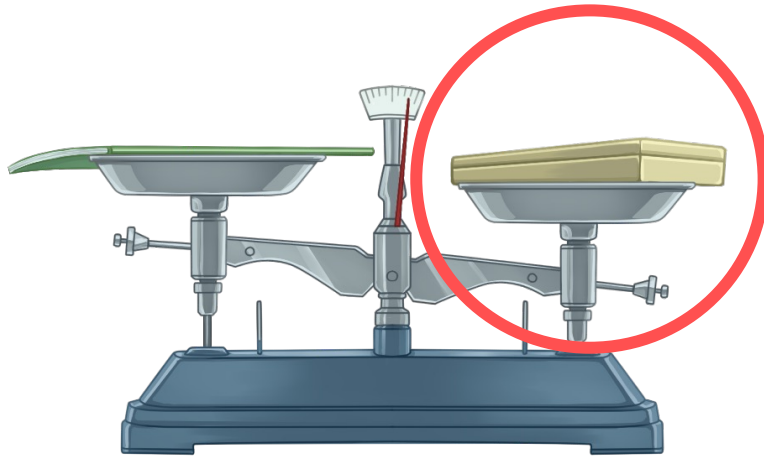

2

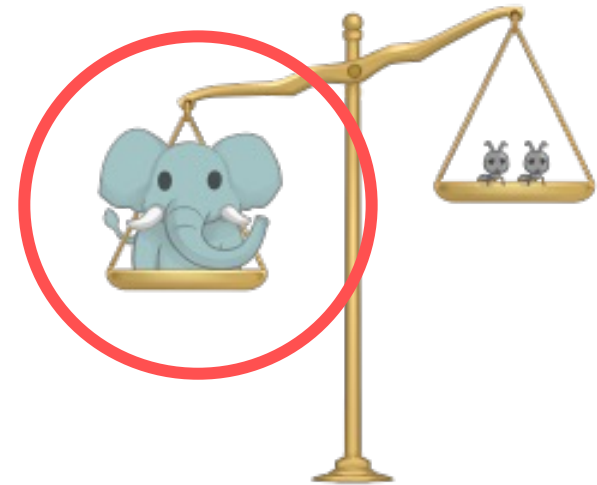

ぶんぼうぐの ながさを くらべるよ。

いちばん ながい ものに まるを つけよう！

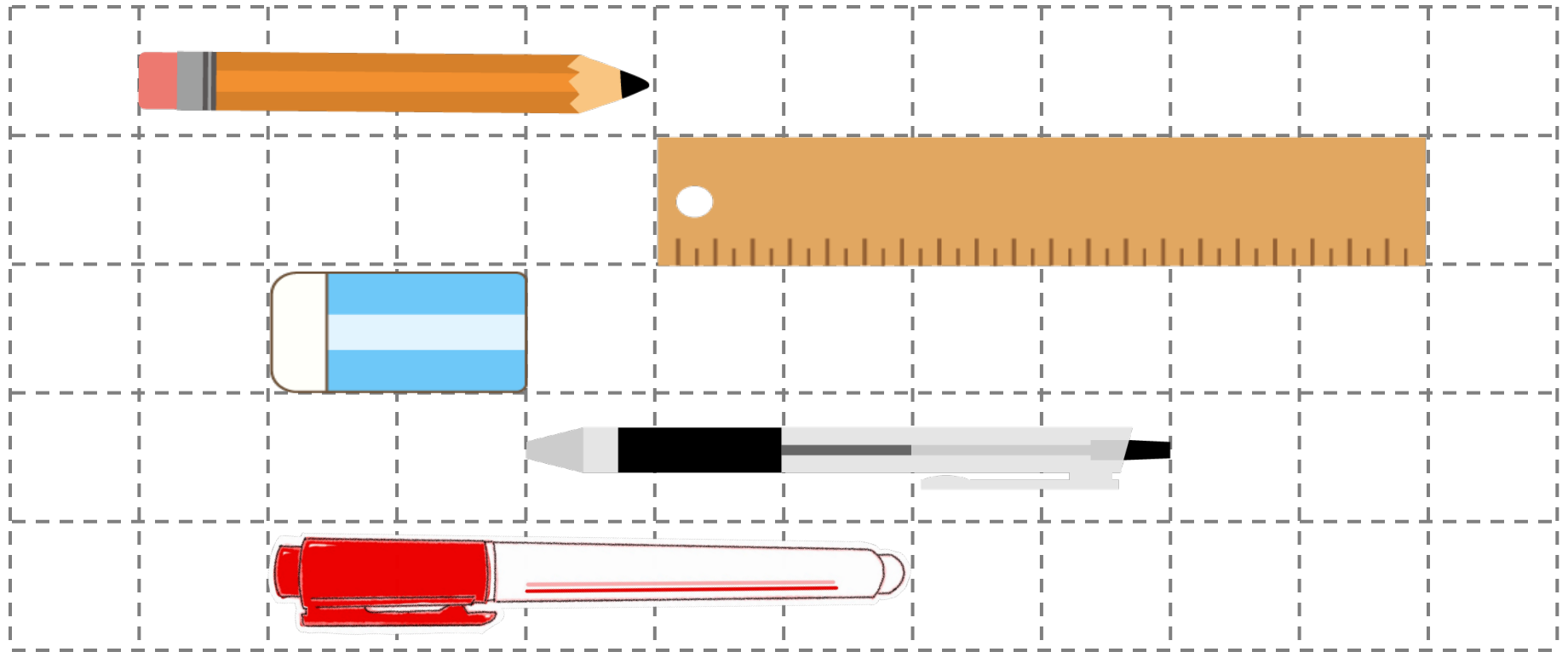

ぶんぼうぐの ながさを くらべるよ。

いちばん ながい ものに まるを つけよう！

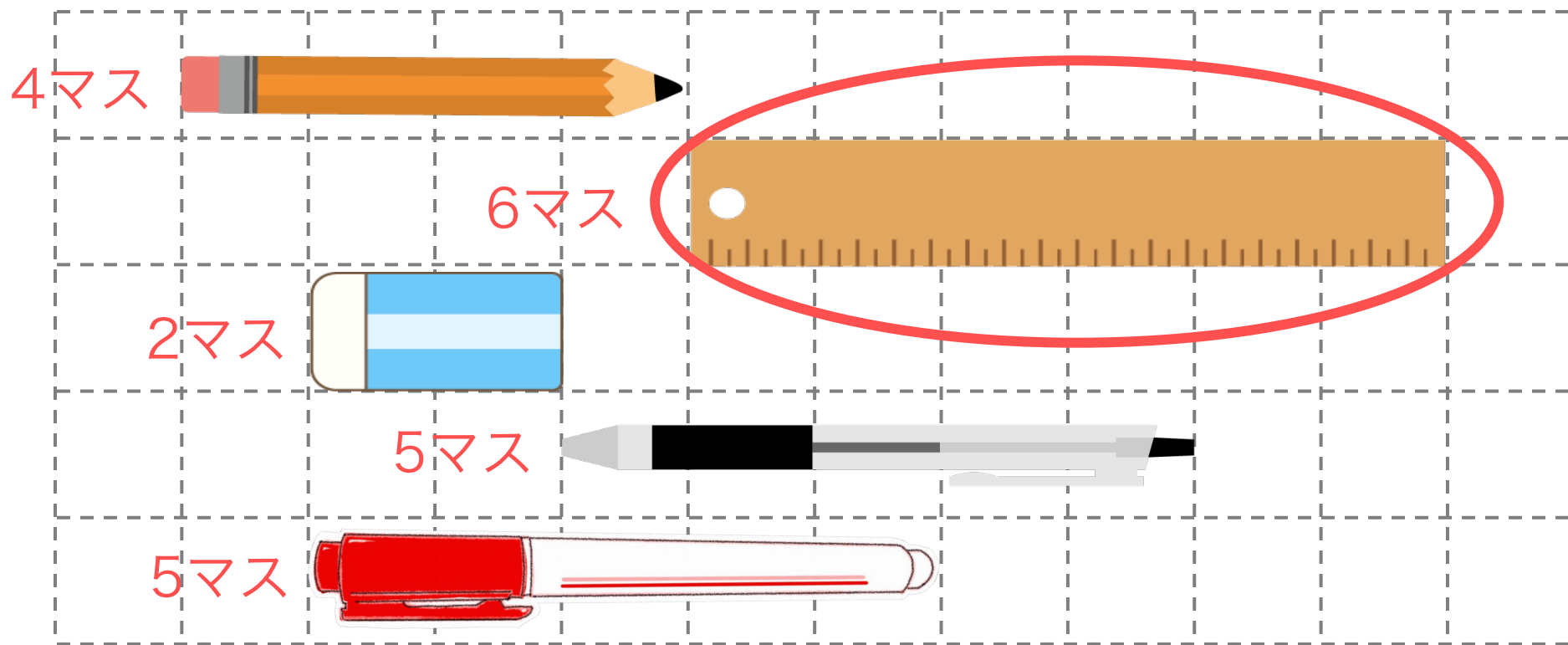

ぶんぼうぐの ながさを くらべるよ。

いちばん ながい ものに まるを つけよう！

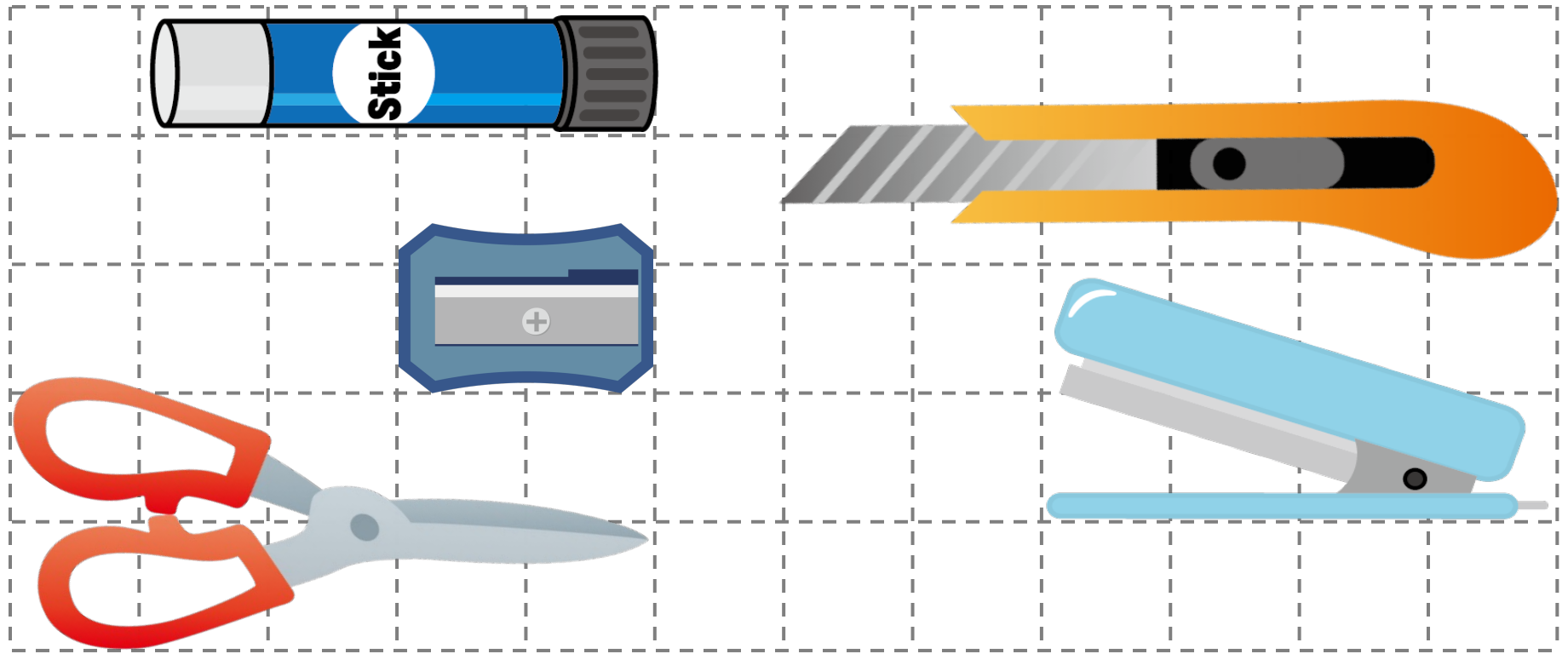

ぶんぼうぐの ながさを くらべるよ。

いちばん ながい ものに まるを つけよう！

4マス



2マス

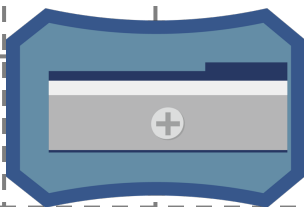

5マス

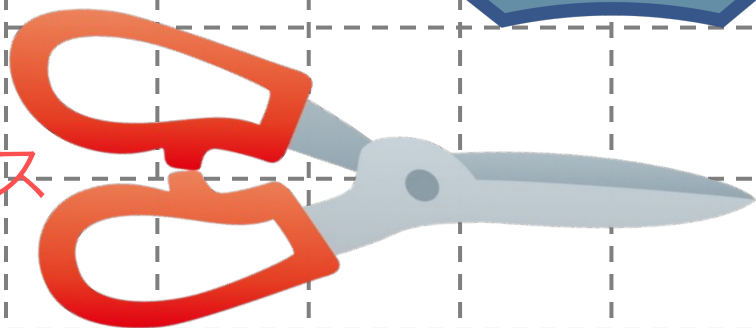

4マス

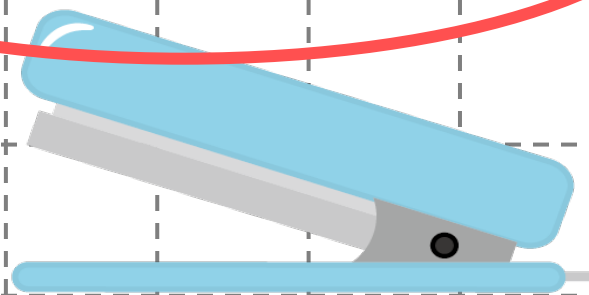

6マス

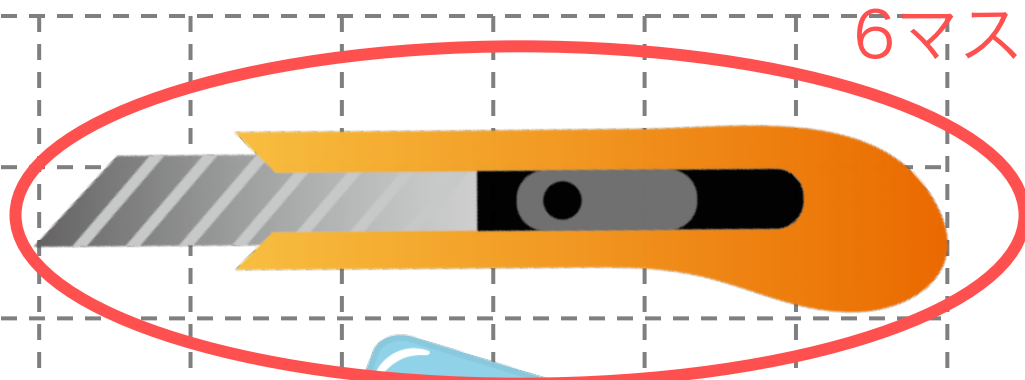

マスの なかに いろが んってあるよ。

どの いろが いちばん ひろいかな？

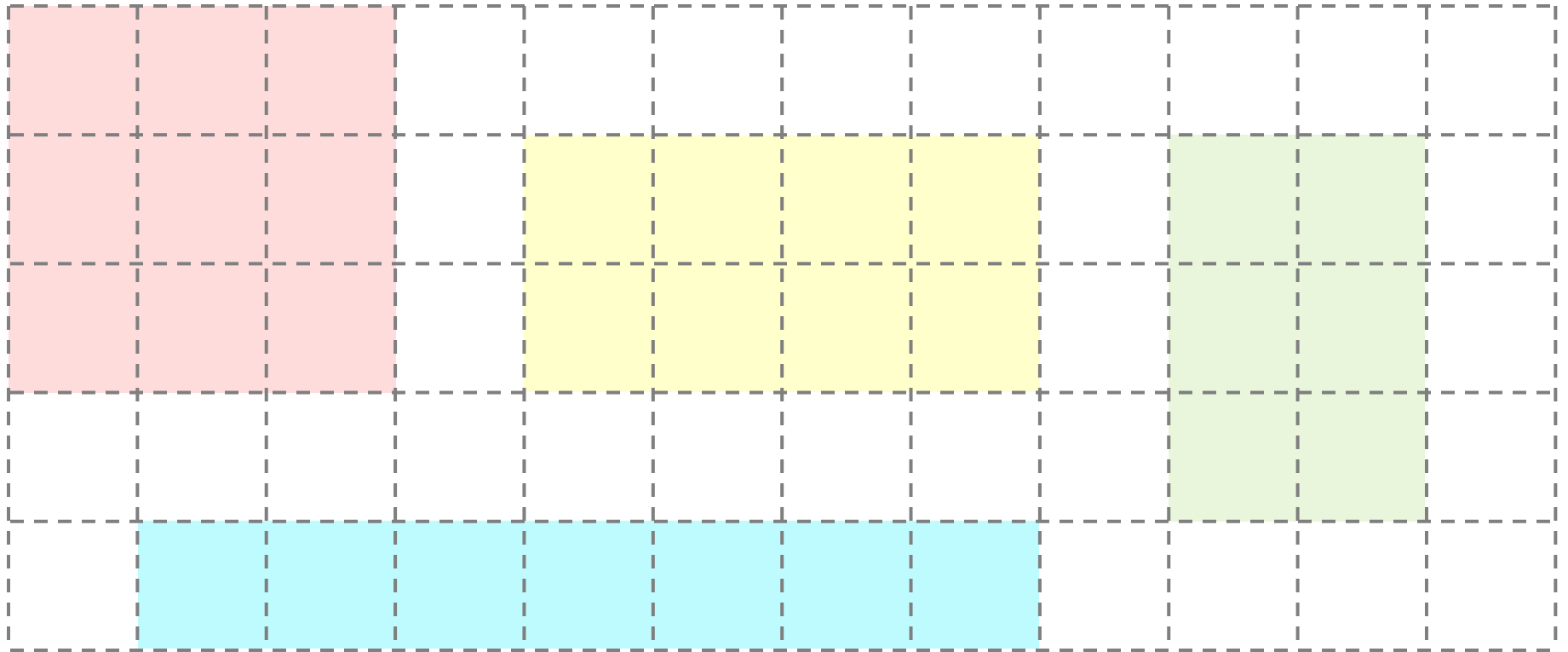

マスの なかに いろが ぬってあるよ。

どの いろが いちばん ひろいかな？

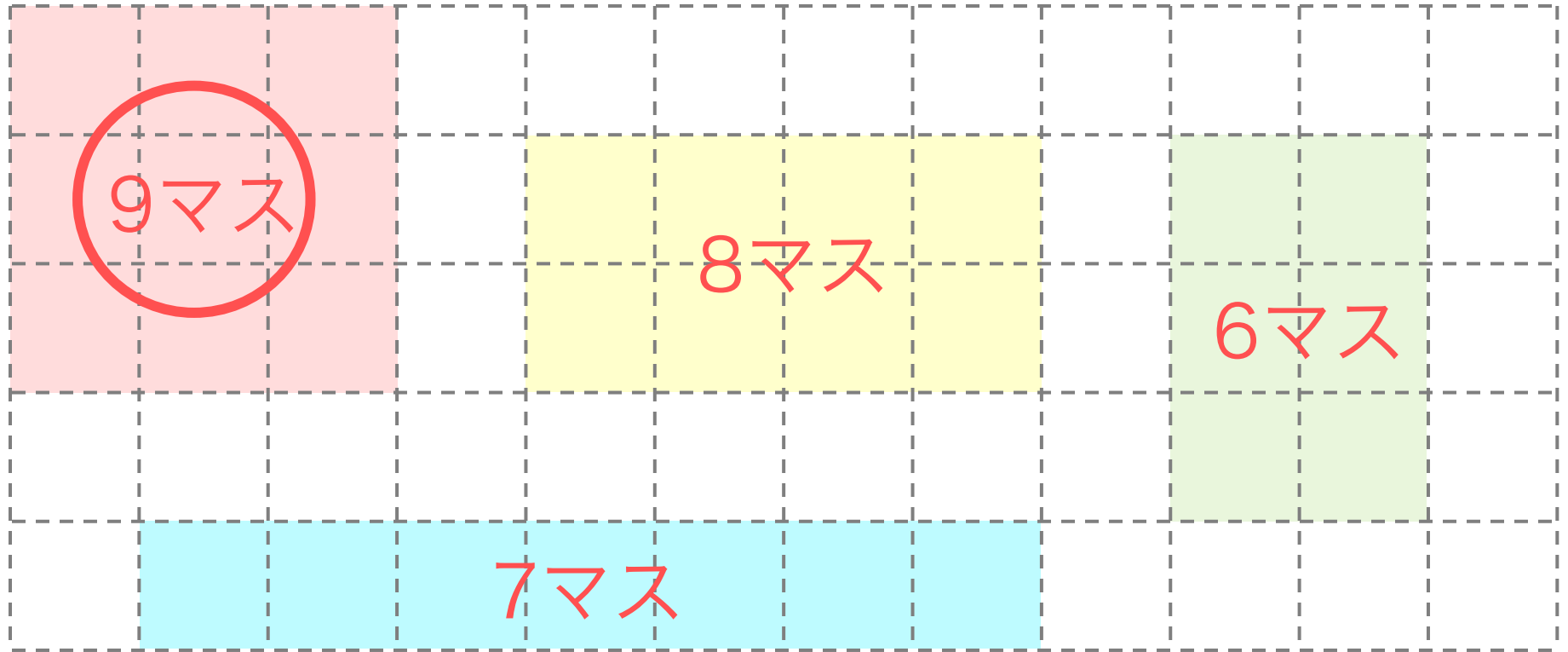

マスの なかに いろが ぬってあるよ。

どの いろが いちばん ひろいかな？

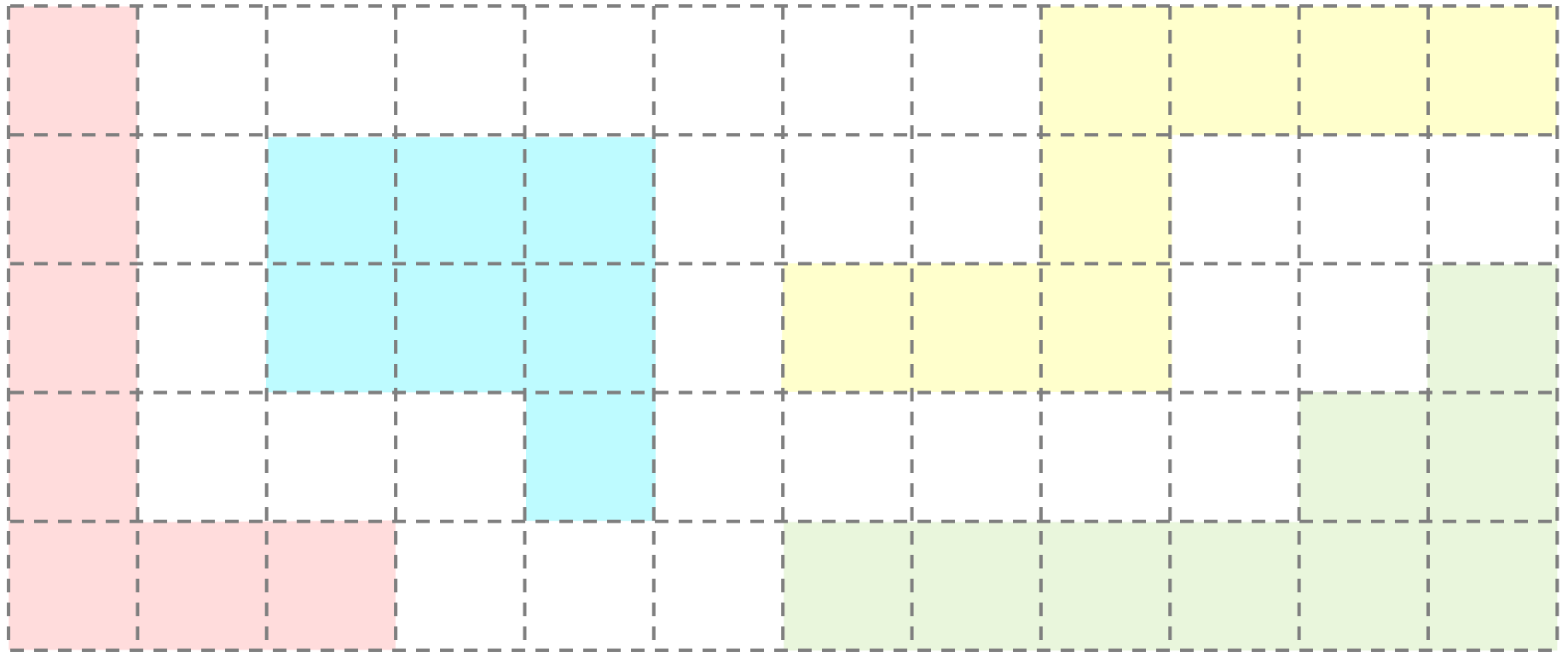

マスの なかに いろが めってあるよ。
どの いろが いちばん ひろいかな？

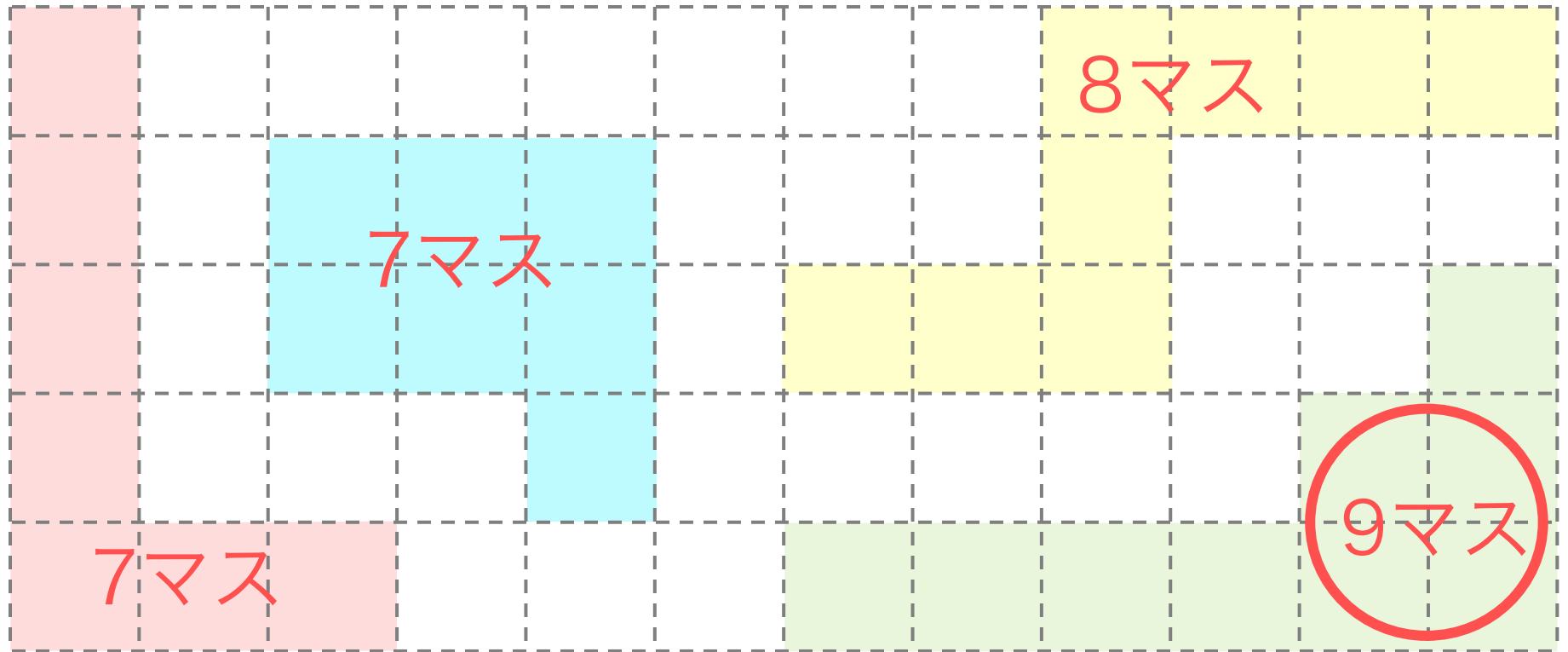

ひだりの かみを ひらくと どんな かたちになるかな？

1

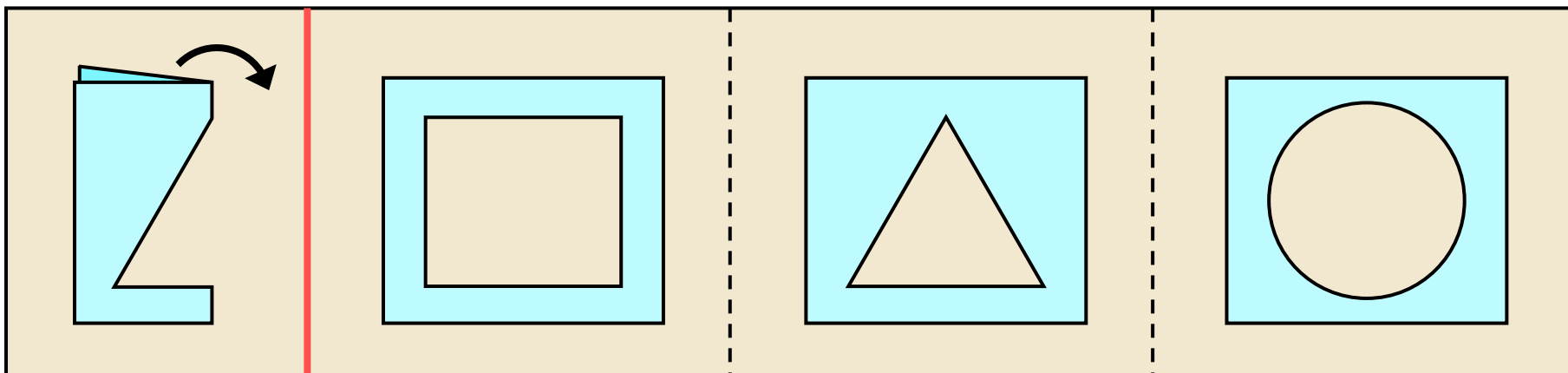

2

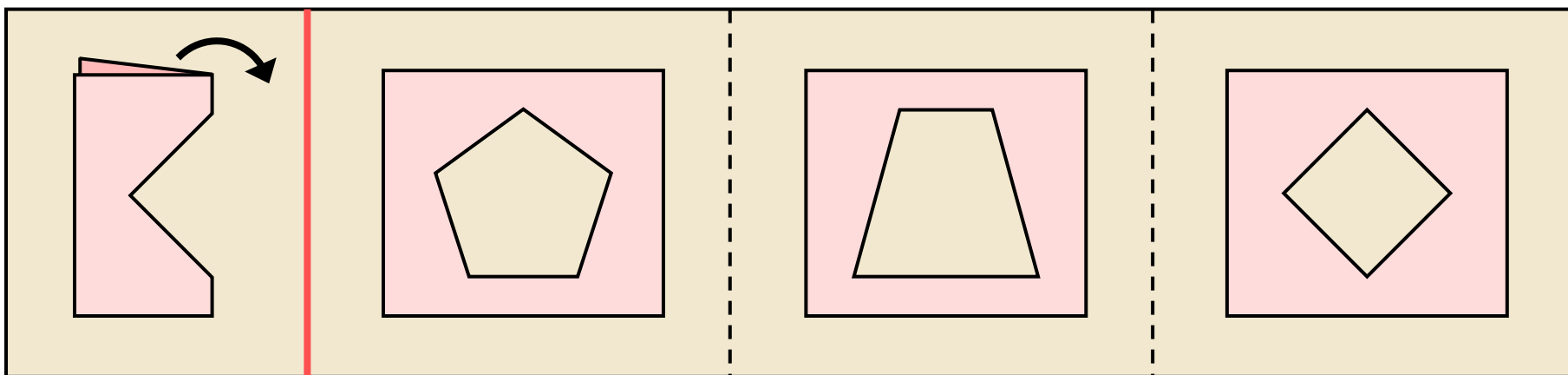

ひだりの かみを ひらくと どんな かたちになるかな？

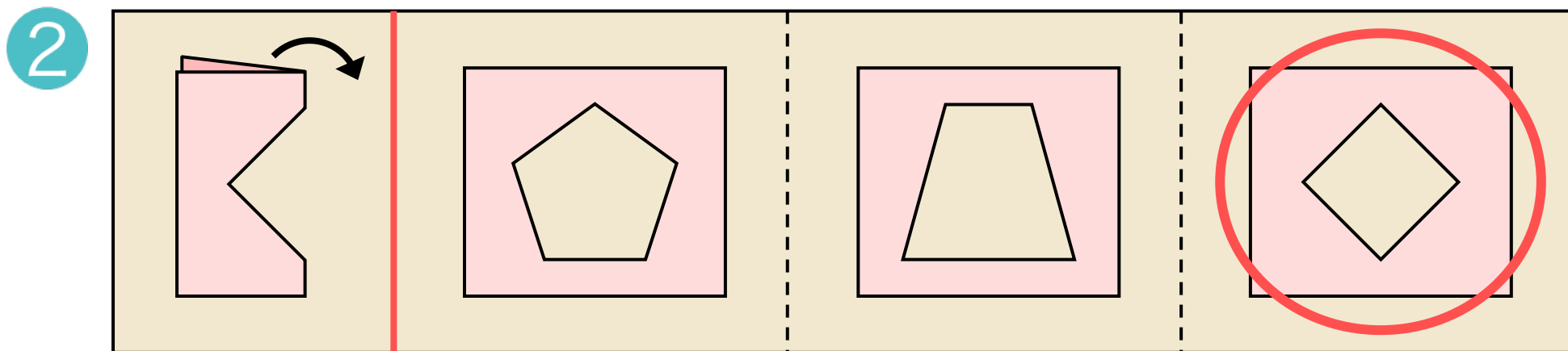
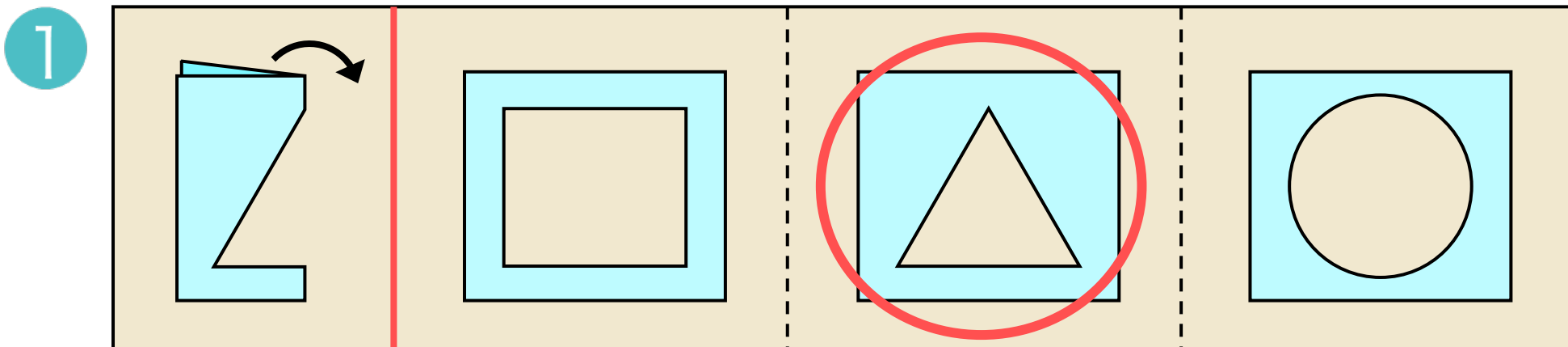

ひだりの かみを ひらくと どんな かたちになるかな？

1

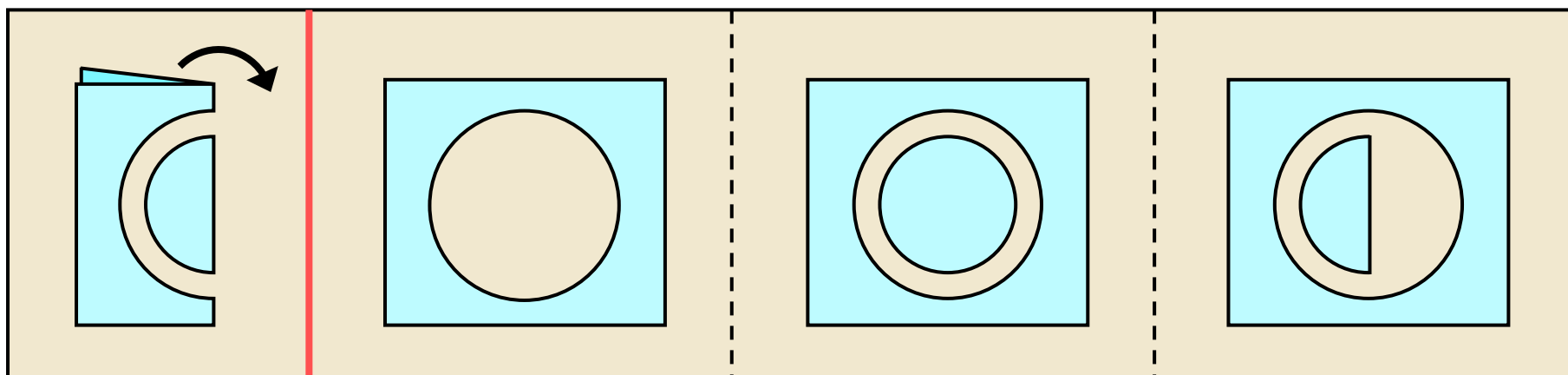

2

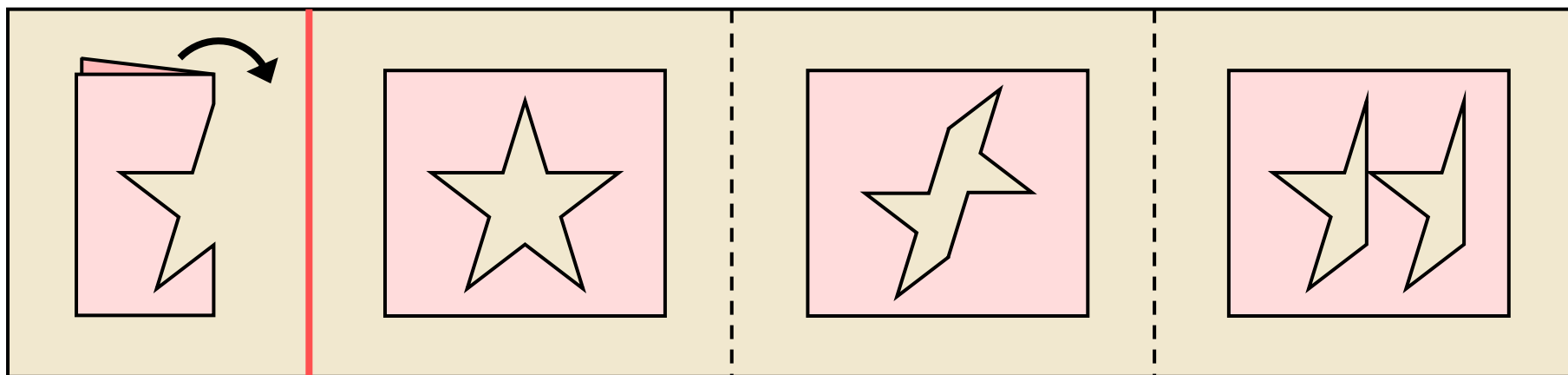

ひだりの かみを ひらくと どんな かたちになるかな？

1

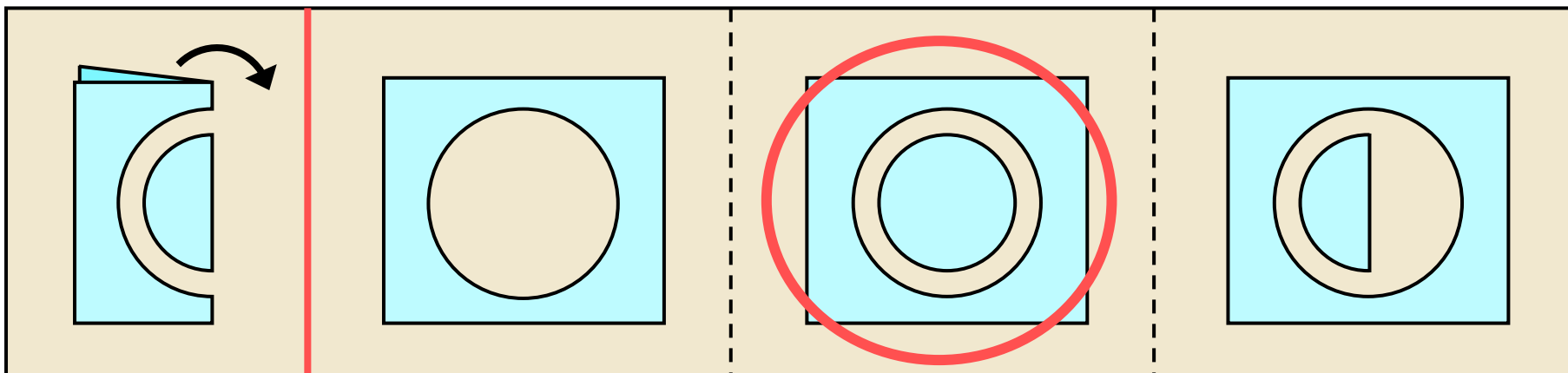

2

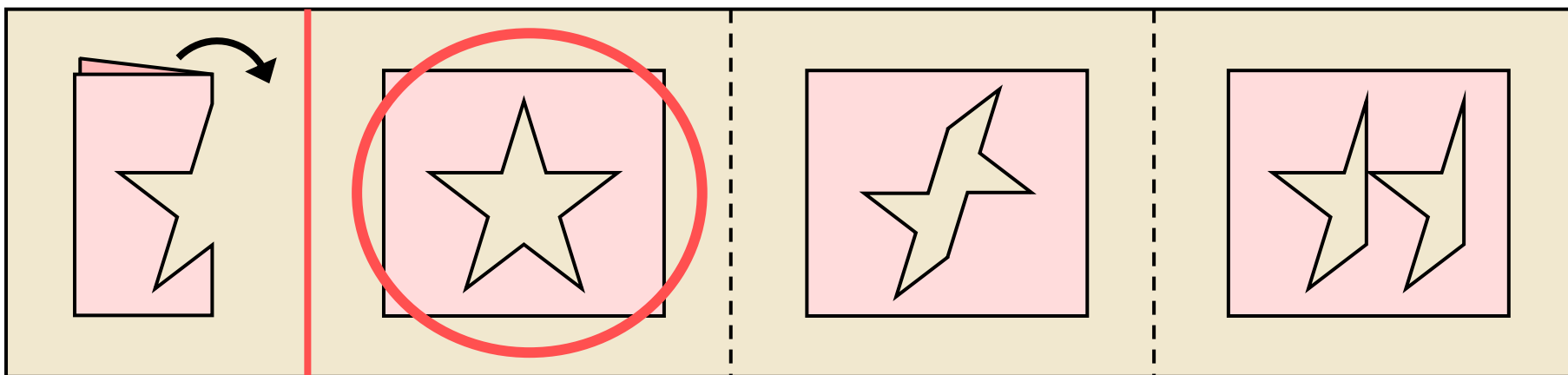

リスコさんの いえから がっこう、えき、びょういんに
いくよ。いちばん とおい ばしょに まるをつけよう！

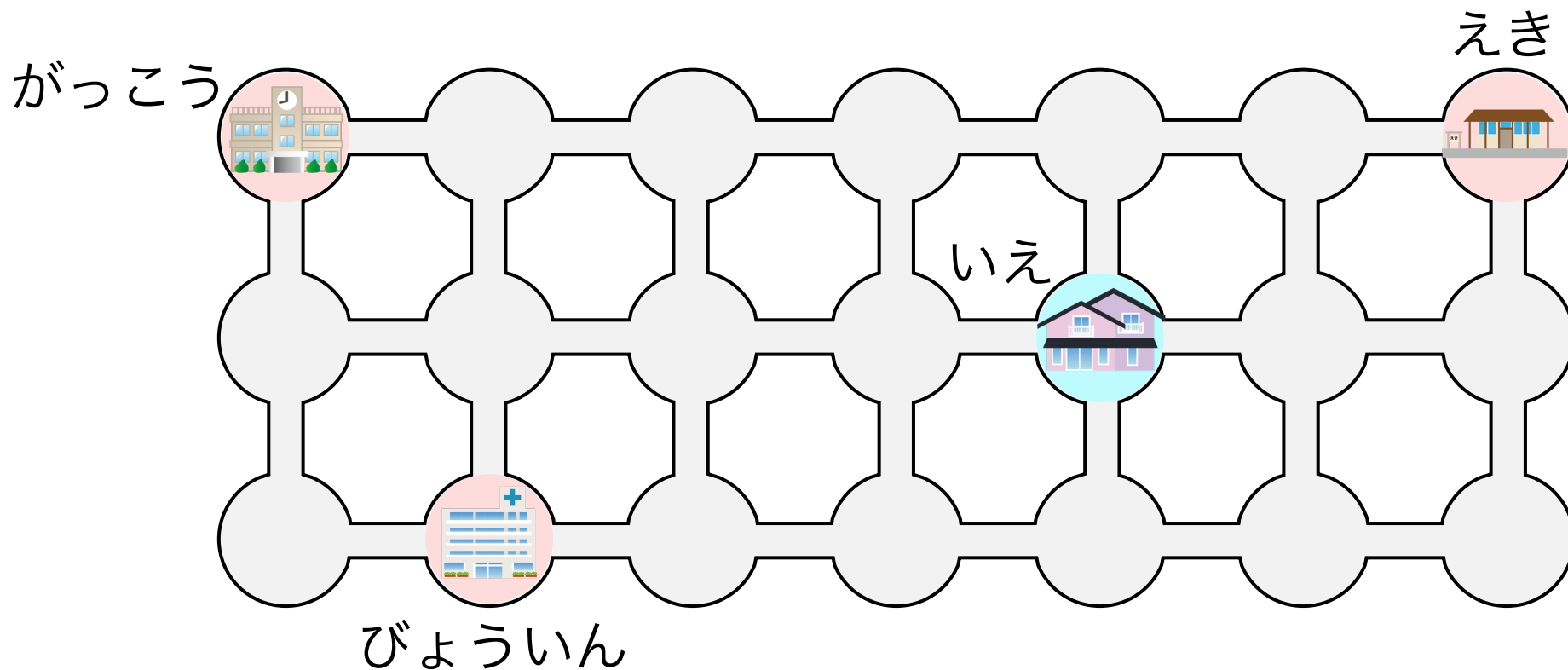

リスコさんの いえから がっこう、えき、びょういんに
いくよ。いちばん とおい ばしょに まるをつけよう！

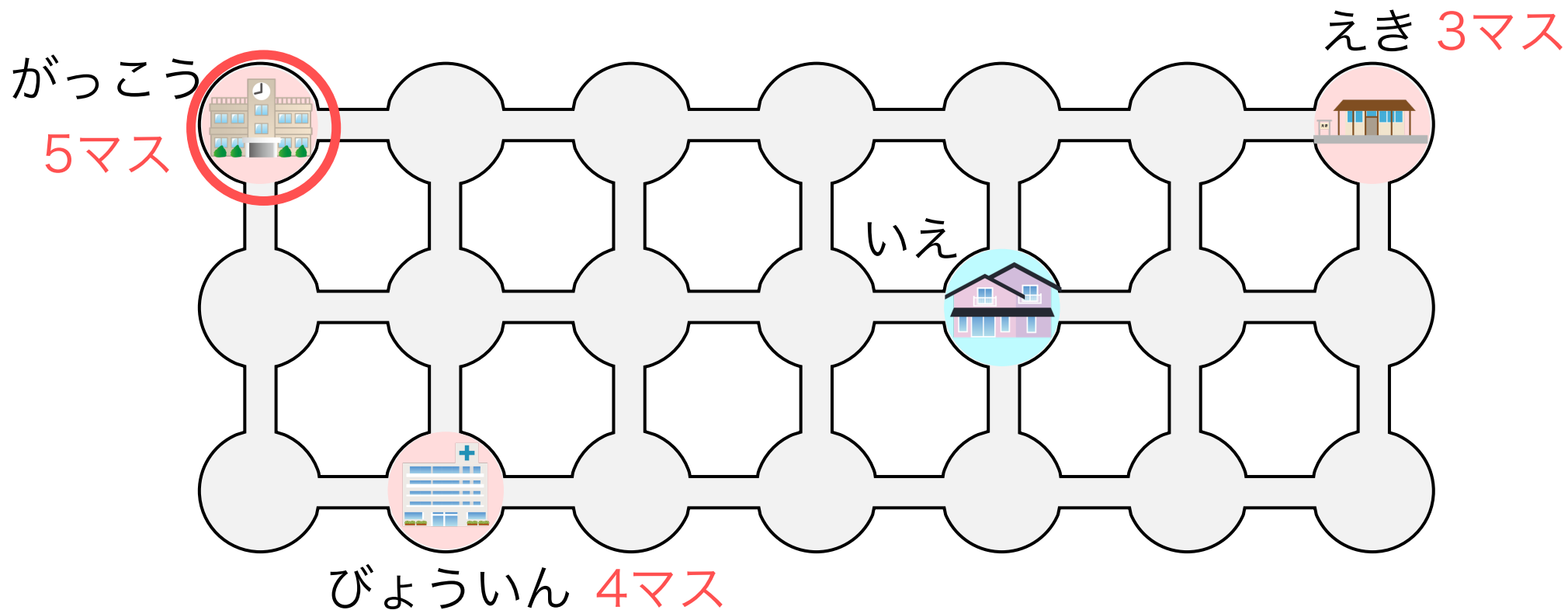

リスタくんの いえから がっこう、えき、びょういんに
いくよ。いちばん とおい ばしょに まるをつけよう！

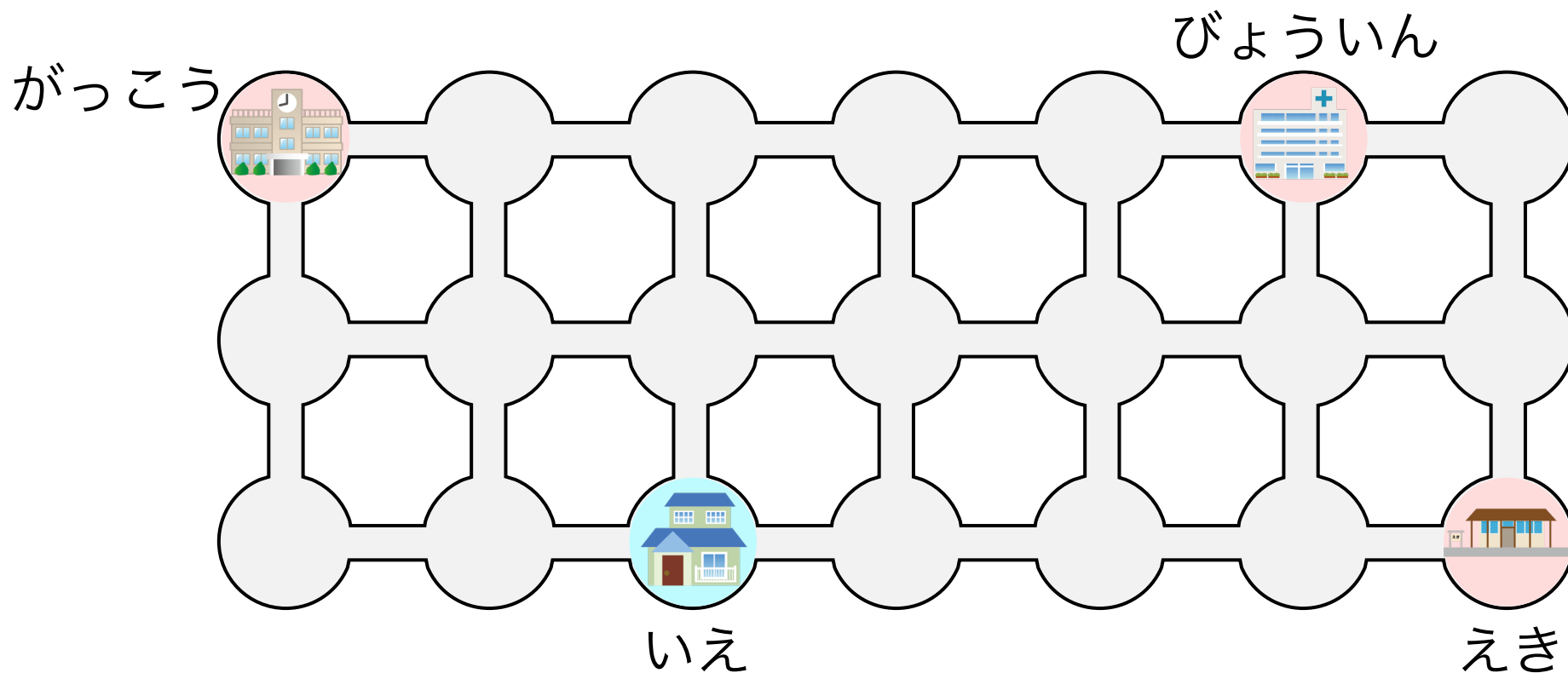

リスタくんの いえから がっこう、えき、びょういんに
いくよ。いちばん とおい ばしょに まるをつけよう！

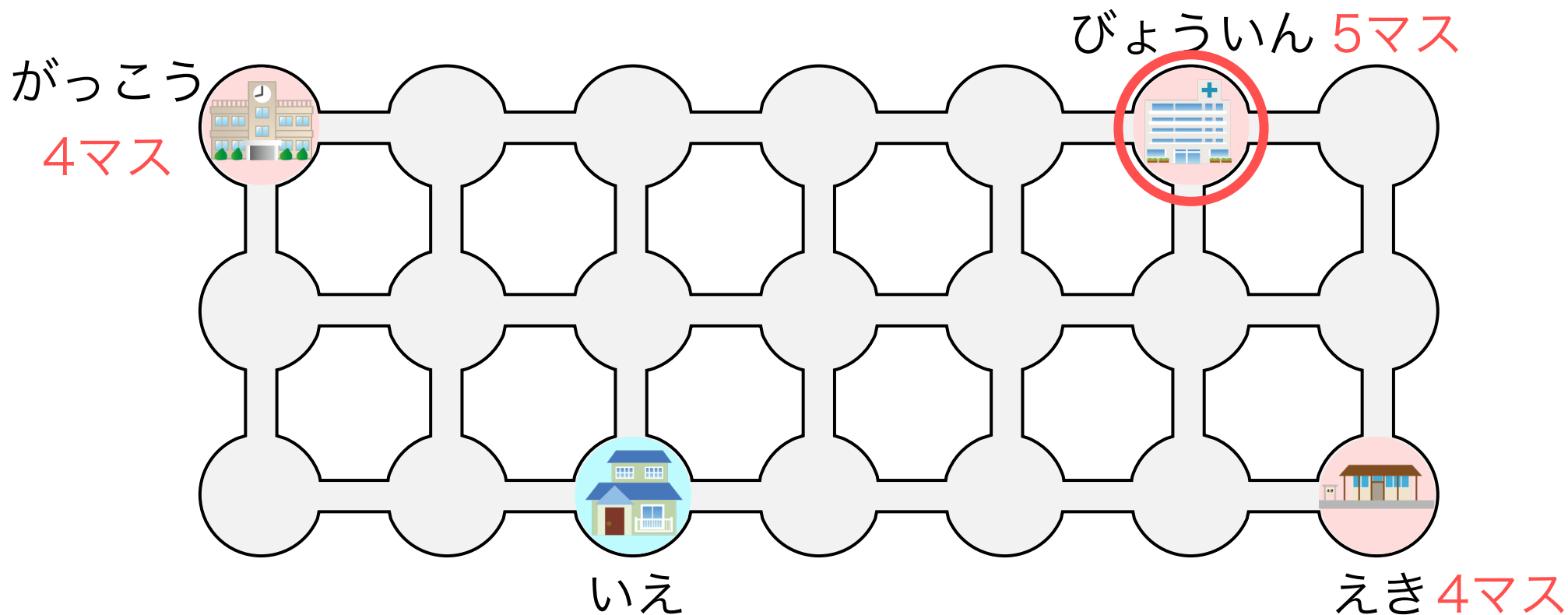

けいさんの こたえの マスに まるを つけよう！
どの れつが ビンゴに なるかな？

① $1 + 4$

② $3 + 5$

③ $8 - 2$

④ $9 - 6$



けいさんの こたえの マスに まるを つけよう！

どの れつが ビンゴに なるかな？

① $1 + 4$

② $3 + 5$

③ $8 - 2$

④ $9 - 6$



けいさんの こたえの マスに まるを つけよう！
どの れつが ビンゴに なるかな？

① $7 + 2$

② $4 + 3$

③ $5 - 1$

④ $8 - 6$



けいさんの こたえの マスに まるを つけよう！
どの れつが ビンゴに なるかな？

① $7 + 2$

② $4 + 3$

③ $5 - 1$

④ $8 - 6$

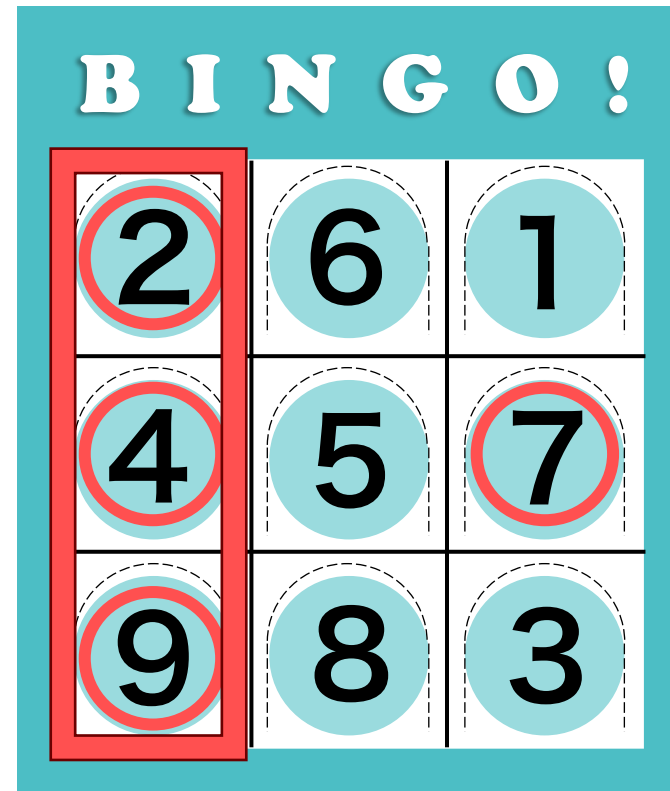

きりとった マスに かいてある かずを たすと

5に なるように きりわけよう！ じょうずに きれるかな？

1

1	2	2
4	1	1
1	3	5

2

2	3	2
2	4	1
1	3	2

わたしは こう きるよ！



きりとった マスに かいてある かずを たすと

5に なるように きりわけよう！ じょうずに きれるかな？

1

1	2	2
4	1	1
1	3	5

2

2	3	2
2	4	1
1	3	2

わたしは こう きるよ！



※別解あり



きりとった マスに かいてある かずを たすと

7に なるように きりわけよう！ じょうずに きれるかな？

1

♠ 2	♠ 2	♥ 3
♦ 1	♦ 1	♠ 2
♦ 1	♣ 4	★ 5

2

♣ 4	♥ 3	♦ 1
♠ 2	♠ 2	♥ 3
♦ 1	♣ 4	♦ 1

★ 5 と ♠ 2 で 7だね！



きりとった マスに かいてある かずを たすと

7に なるように きりわけよう！ じょうずに きれるかな？

1

♠ 2	♠ 2	♥ 3
♦ 1	♦ 1	♠ 2
♦ 1	♣ 4	★ 5

2

♣ 4	♥ 3	♦ 1
♠ 2	♠ 2	♥ 3
♦ 1	♣ 4	♦ 1

★ 5 と ♠ 2 で 7だね！



※別解あり

